

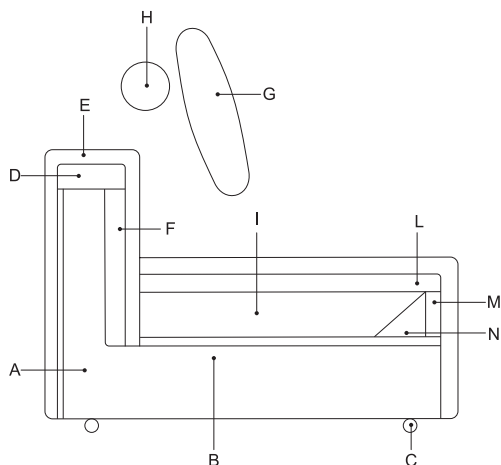

henné  
FL240



- A** **Struttura portante in massello di legno, pannelli particelle di sfogliato di pioppo.**  
Main structure in solid wood, panel in poplar chipboard
- B** **Molle con cinghie elastiche ad alta resistenza**  
Springs with high-resistance elastic belts
- C** **Piedini ABS, a richiesta metallo cromato**  
ABS feet, available in chromed metal upon request
- D** **Poliuretano espanso D 75 sr**  
Polyurethane D 75 sr
- E** **Resinato accoppiato a vellutino gr. 200m<sup>2</sup>**  
Foam combined with interliner velvet gr. 200m<sup>2</sup>
- F** **Poliuretano espanso D 21**  
Polyurethane D 21
- G** **Piuma + fibra poliestere suddivisa in scomparti rivestito in pelleovo**  
Down + polyester fiber divided in compartment covered with muslin of cotton material
- H** **Poliuretano espanso D 21**  
Polyurethane D 21
- I** **Poliuretano espanso D 30**  
Polyurethane D 30
- L** **Fibra poliestere gr. 200m<sup>2</sup>**  
Polyester fiber gr. 200m<sup>2</sup>
- M** **Poliuretano espanso D 10**  
Polyurethane D 10
- N** **Poliuretano espanso D 35**  
Polyurethane D 35

**DI SERIE PIEDI ABS**

Standard feet in ABS

<p>altezza height 60 cm profondità depth 100 cm</p>	<p><b>Completamente sfoderabile (esclusa versione pelle)</b></p> <p>Completely removable cover (except for leather version)</p>	TESSUTO / fabric			PELLE / leather	
		SOFAST	VANITY	CLIENTE	URUGUAY	NABUK

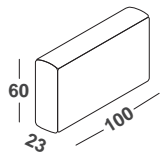

### BRACCIOLO 60x23 CM

60x23 cm armrest

m<sup>3</sup> 0,20 | Kg 11 | colli 0

ml. Base I.m. Structure 2,00

ml. Cuscini I.m. Cushion

Note:

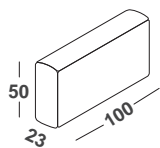

### BRACCIOLO 50x23 CM

50x23 cm armrest

m<sup>3</sup> 0,15 | Kg 11 | colli 0

ml. Base I.m. Structure 1,80

ml. Cuscini I.m. Cushion

Note:

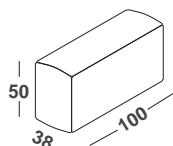

### BRACCIOLO 50x38 CM

50x38 cm armrest

m<sup>3</sup> 0,20 | Kg 11 | colli 0

ml. Base I.m. Structure 2,50

ml. Cuscini I.m. Cushion

Note:

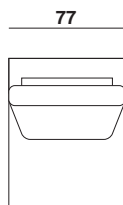

### ELEMENTO CENTRALE 77 CM

77 cm central element

m<sup>3</sup> 0,50 | Kg 35 | colli 1

ml. Base I.m. Structure 2,80

ml. Cuscini I.m. Cushion 2,90

Note:

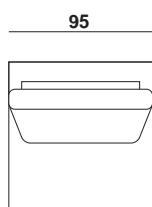

### ELEMENTO CENTRALE 95 CM

95 cm central element

m<sup>3</sup> 0,70 | Kg 39 | colli 1

ml. Base I.m. Structure 2,80

ml. Cuscini I.m. Cushion 3,20

Note:

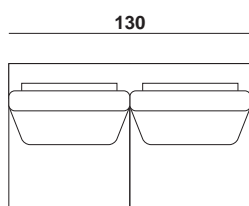

### ELEMENTO CENTRALE 130 CM

130 cm central element

m<sup>3</sup> 0,90 | Kg 45 | colli 1

ml. Base I.m. Structure 2,90

ml. Cuscini I.m. Cushion 4,30

Note:

 <p>altezza height 60 cm</p> <p>profondità depth 100 cm</p> <p>42</p>	<p><b>Completamente sfoderabile (esclusa versione pelle)</b></p> <p>Completely removable cover (except for leather version)</p>	TESSUTO / fabric			PELLE / leather	
		SOFAST	VANITY	CLIENTE	URUGUAY	NABUK

150

### ELEMENTO CENTRALE 150 CM

150 cm central element

m<sup>3</sup> 1,00 | Kg 52 | colli 1

ml. Base l.m. Structure 4,30

ml. Cuscini l.m. Cushion 5,20

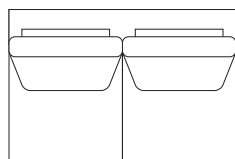

Note:

170

### ELEMENTO CENTRALE 170 CM

170 cm central element

m<sup>3</sup> 1,10 | Kg 59 | colli 1

ml. Base l.m. Structure 4,30

ml. Cuscini l.m. Cushion 5,50

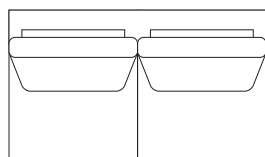

Note:

190

### ELEMENTO CENTRALE 190 CM

190 cm central element

m<sup>3</sup> 1,20 | Kg 66 | colli 1

ml. Base l.m. Structure 4,30

ml. Cuscini l.m. Cushion 5,80

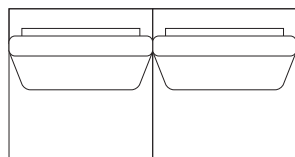

Note:

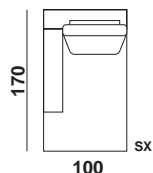

### PENISOLA 170 CM DX-SX

RH-LH chaise longue 170 cm

m<sup>3</sup> 1,10 | Kg 47 | colli 1

ml. Base l.m. Structure 3,70

ml. Cuscini l.m. Cushion 3,80

Note:

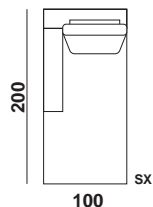

### PENISOLA 200 CM DX-SX

RH-LH chaise longue 200 cm

m<sup>3</sup> 1,25 | Kg 59 | colli 1

ml. Base l.m. Structure 4,20

ml. Cuscini l.m. Cushion 4,40

Note:

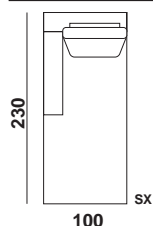

### PENISOLA 230 CM DX-SX

RH-LH chaise longue 230 cm

m<sup>3</sup> 1,80 | Kg 75 | colli 1

ml. Base l.m. Structure 4,70

ml. Cuscini l.m. Cushion 4,80

Note:

 <p>altezza height 60 cm</p> <p>profondità depth 42 cm</p> <p>100</p>	<p><b>Completamente sfoderabile (esclusa versione pelle)</b></p> <p>Completely removable cover (except for leather version)</p>	TESSUTO / fabric			PELLE / leather	
		SOFAST	VANITY	CLIENTE	URUGUAY	NABUK

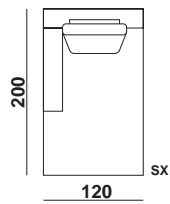

### PENISOLA 200 CM DX-SX PROF. 120 CM

RH-LH chaise longue 200 cm Depth 120 cm

m<sup>3</sup> 1,25 | Kg 59 | colli 1

ml. Base l.m. Structure 4,80

ml. Cuscini l.m. Cushion 5,10

Note:

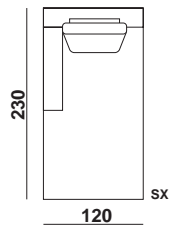

### PENISOLA 230 CM DX-SX PROF. 120 CM

RH-LH chaise longue 230 cm Depth 120 cm

m<sup>3</sup> 1,80 | Kg 75 | colli 1

ml. Base l.m. Structure 5,30

ml. Cuscini l.m. Cushion 5,40

Note:

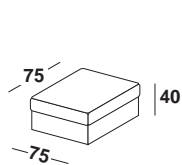

### POUF 75x75 CM con cuscino seduta

75x75 pouf with cushion

m<sup>3</sup> 0,60 | Kg 39 | colli 1

ml. Base l.m. Structure 2,10

ml. Cuscini l.m. Cushion 2,30

Note:

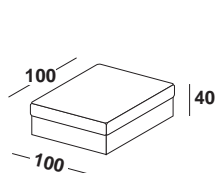

### POUF 100x100 CM con cuscino seduta

100x100 pouf with cushion

m<sup>3</sup> 0,60 | Kg 39 | colli 1

ml. Base l.m. Structure 2,70

ml. Cuscini l.m. Cushion 2,80

Note:



### CUSCINO PIUMA 45x45 CM

45x45 cm feather cushion

ml. Cuscini l.m. Cushion 0,60

Note:

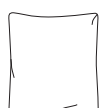

### CUSCINO PIUMA 60x60 CM

60x60 cm feather cushion

ml. Cuscini l.m. Cushion 0,70

Note:

 <p>altezza height 60 cm</p> <p>profondità depth 100 cm</p>	<p><b>Completamente sfoderabile (esclusa versione pelle)</b></p> <p>Completely removable cover (except for leather version)</p>	<p><b>TESSUTO / fabric</b></p>			<p><b>PELLE / leather</b></p>	
		<p>SOFAST</p>	<p>VANITY</p>	<p>CLIENTE</p>	<p>URUGUAY</p>	<p>NABUK</p>

**MAGGIORAZIONE PIEDE ACCIAIO**

Surcharge for steel feet



Note: Set 4 pezzi  
Set 4 pieces

**MODALITÀ FORMAZIONE ANGOLO / HOW TO FORM CORNER SOFA**

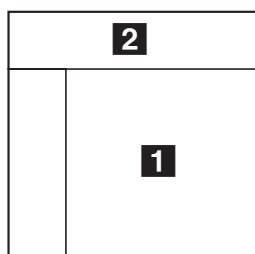

ESEMPIO  
Example

- 1** Elemento da 77/95/130/150/170/190  
77/95/130/150/170/190 element
- 2** Bracciolo H.60 x L.23 x P.100  
Armrest H.60 x W.23 x D.100

